

Respiration Tubings

19 mm Respiration Tubings for Adults made of Silicone

autoclavable up to 134°C

Color: light green (coil), clear (tube),

Length	REF	Box
30 cm	66-22-030	1
40 cm	66-22-040	1
60 cm	66-22-060	1
80 cm	66-22-080	1
90 cm	66-22-090	1
110 cm	66-22-110	1
130 cm	66-22-130	1
150 cm	66-22-150	1
180 cm	66-22-180	1
200 cm	66-22-200	1

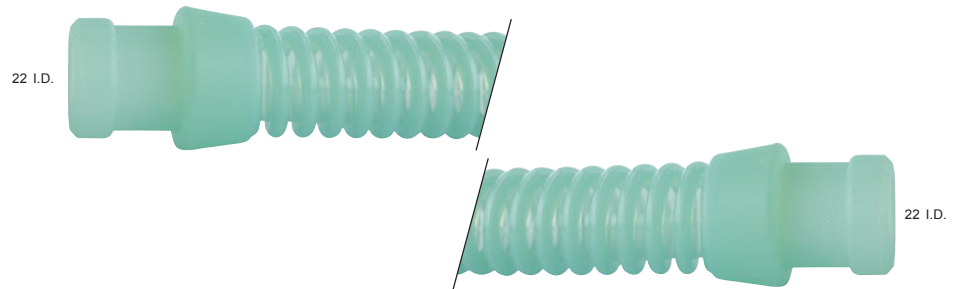

Color: clear (coil and tube)

Length	REF	Box
30 cm	66-22-030tr	1
40 cm	66-22-040tr	1
60 cm	66-22-060tr	1
80 cm	66-22-080tr	1
90 cm	66-22-090tr	1
110 cm	66-22-110tr	1
130 cm	66-22-130tr	1
150 cm	66-22-150tr	1
180 cm	66-22-180tr	1
200 cm	66-22-200tr	1

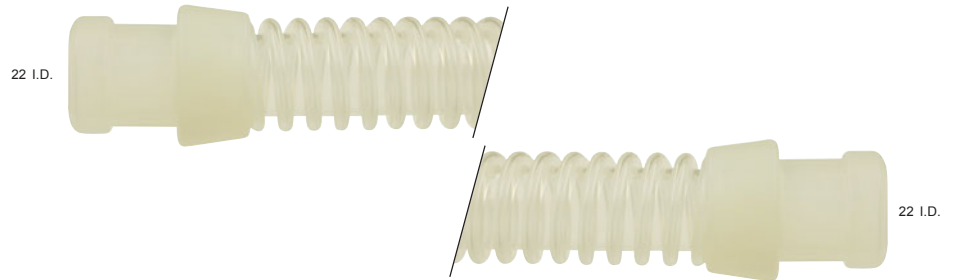

19 mm Respiration Tubings for Adults with angled cuff made of Silicone

Color: light green (coil), clear (tube), autoclavable up to 134°C

Length	REF	Box
25 cm	66-22-925	1
40 cm	66-22-940	1

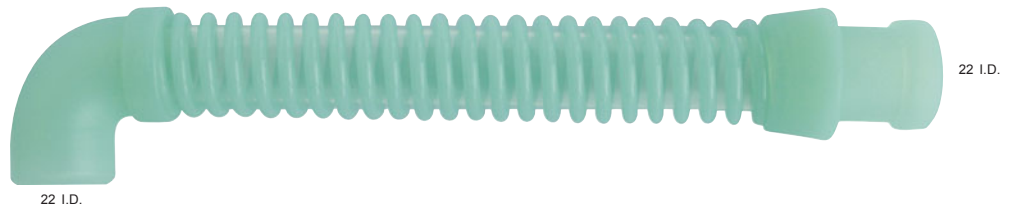

16 mm "Lightweight Tubings" for Adults made of Silicone

Color: light green (coil), clear (tube), autoclavable up to 134°C

- light weight due to smaller tube and thinner coil
- high stability
- longer lasting than autoclavable plastic tubings

Length	REF	Box
30 cm	69-16-030	1
45 cm	69-16-045	1
60 cm	69-16-060	1
90 cm	69-16-090	1
110 cm	69-16-110	1
130 cm	69-16-130	1
150 cm	69-16-150	1
180 cm	69-16-180	1
200 cm	69-16-200	1

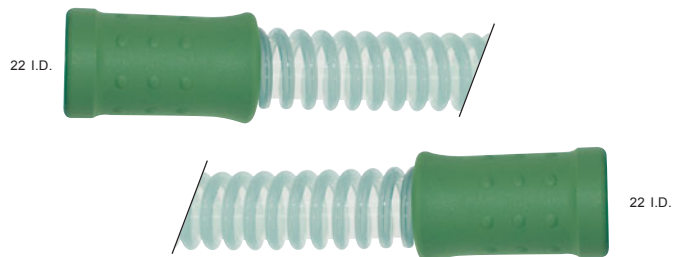

Hook made of Silicone

for 9 mm / 19 mm Respiration Tubings

REF 66-00-002 Box 5



Straight Connector

to connect and extend Adult Silicone Respiration Tubings with 22 mm cuffs, Material: POM, autoclavable up to 134°C

REF 60-15-110 Box 1

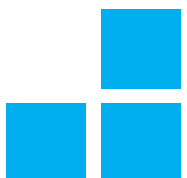

Respiration Tubings

9 mm Respiration Tubings for Pediatric made of Silicone

Color: light green (coil), clear (tube), autoclavable up to 134°C

with 10 mm cuff at both ends

Length	REF	Box
25 cm	66-10-025	1
45 cm	66-10-045	1
60 cm	66-10-060	1
85 cm	66-10-085	1
110 cm	66-10-110	1
130 cm	66-10-130	1
150 cm	66-10-150	1
200 cm	66-10-200	1

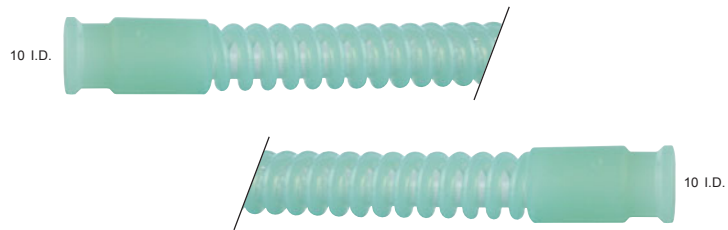

with 10 mm/22 mm cuffs

Length	REF	Box
25 cm	66-11-025	1
45 cm	66-11-045	1
60 cm	66-11-060	1
85 cm	66-11-085	1
110 cm	66-11-110	1
130 cm	66-11-130	1
150 cm	66-11-150	1
170 cm	66-11-170	1
200 cm	66-11-200	1

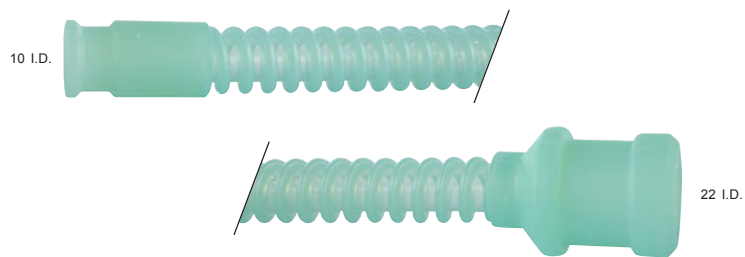

with 22 mm cuff at both ends

Length	REF	Box
25 cm	66-12-025	1
60 cm	66-12-060	1
85 cm	66-12-085	1
110 cm	66-12-110	1
130 cm	66-12-130	1
150 cm	66-12-150	1
170 cm	66-12-170	1
200 cm	66-12-200	1

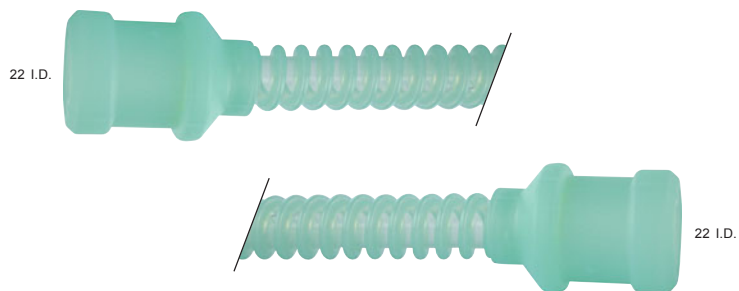

9 mm "Lightweight Tubings" for Pediatric made of Silicone

Color: light green (coil), clear (tube), autoclavable up to 134°C

- light weight due to thinner coil
- high stability
- longer lasting than autoclavable plastic tubings

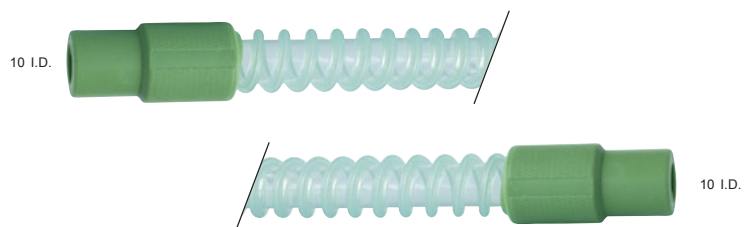

with 10 mm cuff at both ends

Length	REF	Box
25 cm	69-10-025	1
45 cm	69-10-045	1
60 cm	69-10-060	1
90 cm	69-10-090	1
110 cm	69-10-110	1
130 cm	69-10-130	1
150 cm	69-10-150	1
170 cm	69-10-170	1
200 cm	69-10-200	1

Rebreathing Bags & Water Traps

Rebreathing Bags made of Silicone

clear, with 22 mm cuff and loop
autoclavable up to 134°C

Standard

Size	REF	Box
500 ml	66-00-011	1
1000 ml	66-00-015	1
1500 ml	66-00-012	1
2300 ml	66-00-013	1
3000 ml	66-00-014	1



with open tube connection

Size	REF	Box
500 ml	66-00-041	1
1000ml	66-00-045	1
1500 ml	66-00-042	1
2300 ml	66-00-043	1
3000 ml	66-00-044	1



with 5 mm hole

Size	REF	Box
500 ml	66-00-441	1
1000 ml	66-00-445	1
1500 ml	66-00-442	1
2300 ml	66-00-443	1
3000 ml	66-00-444	1



Water Traps

autoclavable up to 134°C, Material: PSU

Adult

REF 66-40-500 Box 6



REF 66-40-520 Box 6



Child

REF 66-40-510 Box 6



Respirator Water Trap

REF 66-40-511 Box 6

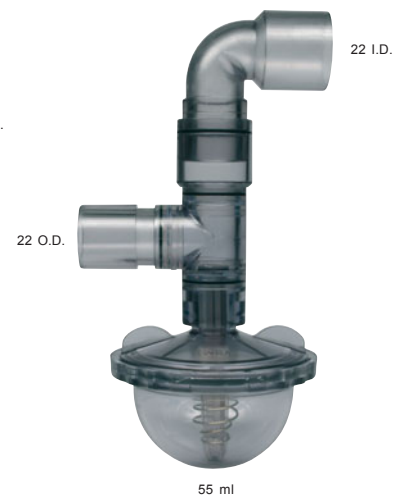

Anesthetic System for Pediatric

reusable, autoclavable up to 134°C

consisting of:

- 2 x 9.0 mm Silicone Respiration Tubing REF 66-11-110
- 1 x 9.0 mm Silicone Respiration Tubing REF 66-12-110
- 1 x Right Angled Y-Connector REF 60-20-100
- 1 x Silicone Rebreathing Bag, 500 ml REF 66-00-011
- 1 x Straight Connector REF 60-12-110

REF 62-11-200 Box 1

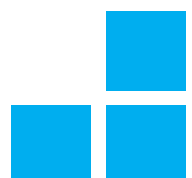

Pediatric Connectors

Right Angled Y-Connectors for Pediatric, swivelling

autoclavable up to 134°C, Material: PSU

“Single Swivel“ Standard

REF 60-20-100 Box 10



15 I.D./
22 O.D.

“Single Swivel“ with female Luer Lock made of metal

REF 60-20-101 Box 10



15 I.D./
22 O.D.

“Single Swivel“ with 3.0 mm bronchoscope/suction cap, blue, also suitable for temperature probes

REF 60-20-200 Box 10



15 I.D./
22 O.D.

“Single Swivel“ with 3.0 mm bronchoscope/suction cap and Luer Lock blue, also suitable for temperature probes

REF 60-20-201 Box 10



15 I.D./
22 O.D.

Right Angled Y-Connectors for Pediatric

autoclavable up to 134°C

“Single Swivel“, closed with two pediatric catheter mount tubings with 15.0 mm connectors

REF 65-20-100 Box 10



15 I.D./
22 O.D.

“Single Swivel“ with 3.0 mm bronchoscope/suction cap and two pediatric catheter mount tubings with 15.0 mm connectors

REF 65-20-200 Box 10



15 I.D./
22 O.D.

Catheter Mount Tubings for Pediatric

autoclavable up to 134°C, Silicone

Length: 9.0 cm REF 65-00-090 Box 10



Length: 10.5 cm REF 65-00-105 Box 10



Pediatric Connectors

Right Angled Y-Connectors for Pediatric Ultra light version

autoclavable up to 134°C, Material: PMP

Standard with Luer connection
(4.0 mm O.D.)

REF 60-20-300 Box 10



with female Luer Lock connection

REF 60-20-301 Box 10



with Luer connection
(4.0 mm O.D.) and with 2.0 mm
bronchoscope/suction cap, yellow

REF 60-20-400 Box 10



Right Angled Y-Connectors for Pediatric

autoclavable up to 134°C, Material: PSU

Standard

REF 60-20-600 Box 10

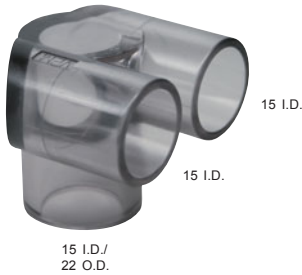

with connection for pressure measuring
(6.0 mm I.D.)

REF 60-20-602 Box 10



with connection for temperature probes
(7.6 mm I.D.)

REF 60-20-603 Box 10



Straight Connectors

suitable for REF 60-20-60x,
autoclavable up to 134°C, Material: PSU



REF 60-30-005 Box 10



REF 60-40-005 Box 10

Straight Connectors

with temperature port
autoclavable up to 134°C, Material: PSU



REF 60-20-703 Box 10



REF 60-20-713 Box 10

Straight Y-Connectors for Pediatric, swivelling

autoclavable up to 134°C, Material: PSU



“Single Swivel” Standard

REF 60-20-500 Box 10



“Single Swivel” with female Luer Lock made of metal

REF 60-20-501 Box 10

Bronchoscope/Suction Cap
made of Silicone, for Y-Connectors

Hole	Color code	REF	Box
3.0 mm	blue	60-60-110	10
2.0 mm	yellow	60-60-112	10



Plug
made of Silicone, for Y-Connectors
REF 60-20-602, ...-603

REF 60-11-999 Box 1

